

**Components and Hardware List (for one chair)**

**Chair Frame With Slip Cover**

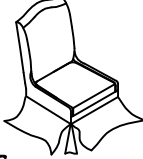

**(A)** 1 pc.

**Legs**

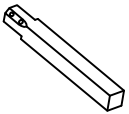

**(B)** 4 pcs.

**M5/16"x1-3/4" Long Head Allen bolt**



**(C)** 8 pcs.

**5/16" Spring Washer**



**(D)** 8 pcs.

**5/16"x19\*2mm Flat Washer**



**(E)** 8 pcs.

**5mm Allen Wrench**



**(F)** 1 pc.

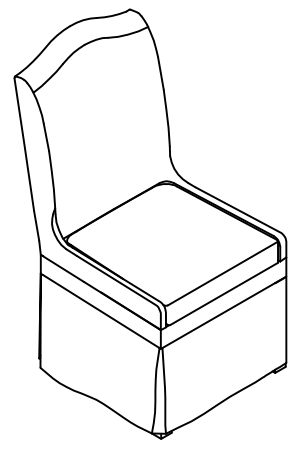

#71949  
Uph Host Chair 2In

Be sure to check all packing material carefully for small parts, which may have come loose inside the carton during shipment. Separate, count and check all parts against the Components and Hardware List above.

**Step 1**

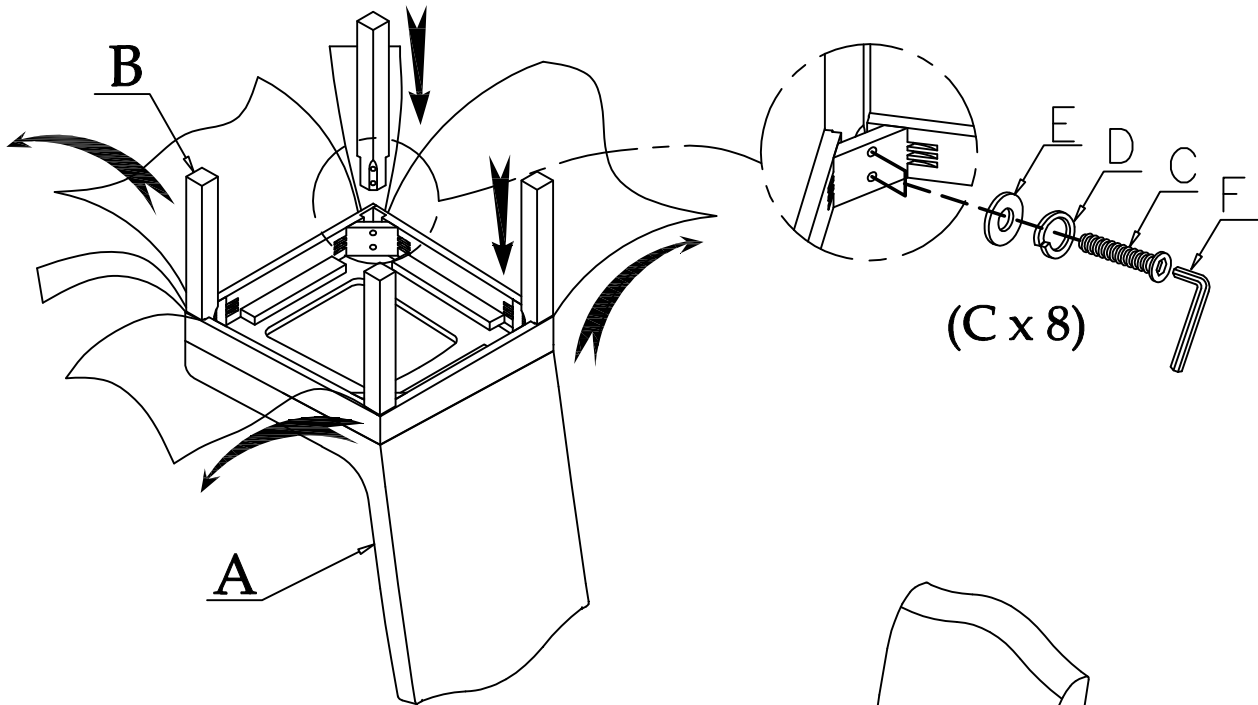

**Step 2**

