









**Components and Hardware List**

<p>Table Top</p>  <p>(A) 1 pc.</p>	<p>Leg</p>  <p>(B) 4 pcs.</p>	<p>Shelf</p>  <p>(C) 1 pc.</p>	<p>Glass</p>  <p>(D) 1 pc.</p>
<p>3/16 x 1/2" Bolt</p>  <p>(E) 4 pcs.</p>	<p>3/16 x 3/4" Bolt</p>  <p>(F) 8 pcs.</p>	<p>3/16" Flat Washer</p>  <p>(G) 12 pcs.</p>	<p>3/16" Lock Washer</p>  <p>(H) 12 pcs.</p>

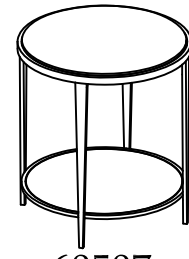

60507

Round End Table

Be sure to check all packing material carefully for small parts which may have come loose inside the carton during shipment.

Identify and count all parts and compare with the parts list above prior to assembly.

In order to avoid possible scratches or damage, it is strongly recommended that this table be assembled by TWO PEOPLE on a soft surface such as a blanket or carpet.

Match the numbers on the leg assemblies to the numbers on the top and stretchers.

Leave all bolts loose until the table is fully assembled, then tighten all bolts.

STEP 1

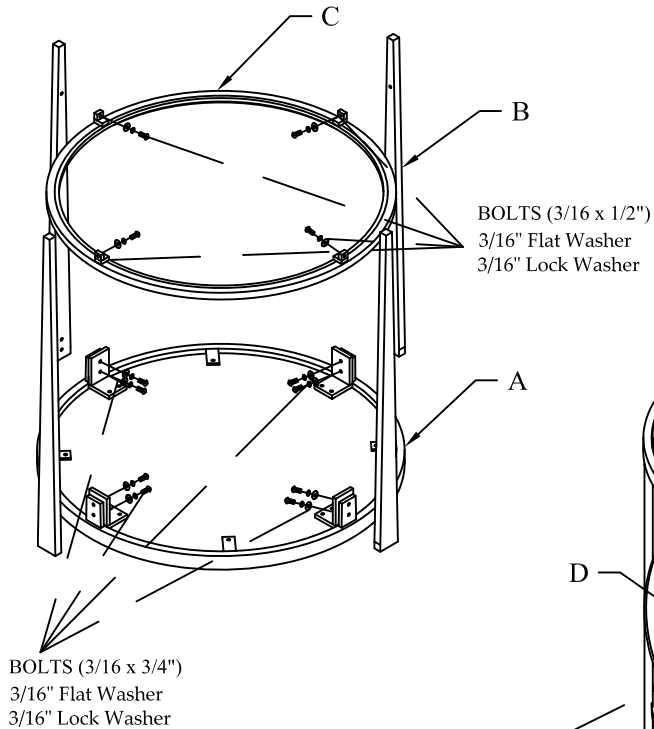

STEP 2

