

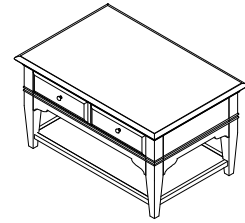







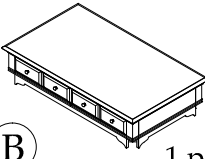
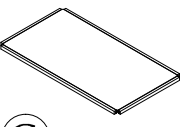
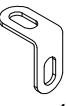
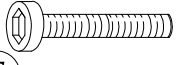

Components and Hardware List

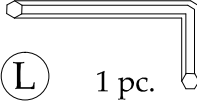

#59503
Cocktable Table

<p>Leg</p>  <p>(A) 4 pcs.</p>	<p>Table Top</p>  <p>(B) 1 pc.</p>	<p>Shelf</p>  <p>(C) 1 pc.</p>	<p>L-Bracket 32*20*18</p>  <p>(D) 4 pcs.</p>	
<p>M5/16"-18 x 2-1/4" Long Allen Head Bolt</p>  <p>(E) 8 pcs.</p>	<p>5/16" Spring Washer</p>  <p>(F) 8 pcs.</p>	<p>5/16" *19*2mm Flat Washer</p>  <p>(G) 8 pcs.</p>	<p>5mm Allen Wrench</p>  <p>(H)</p>	<p>M1/4"-20 x 1/2" Long Allen Head Bolt</p>  <p>(I) 8 pcs.</p>
<p>1/4" Spring Washer</p>  <p>(J) 8 pcs.</p>	<p>1/4" *16*2mm Flat Washer</p>  <p>(K) 8 pcs.</p>	<p>4mm Allen Wrench</p>  <p>(L) 1 pc.</p>	<p>Caster</p>  <p>(M) 4 pcs.</p>	<p>12mm Open Wrench</p>  <p>(N) 1 pc.</p>

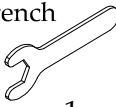
Be sure to check all packing material carefully for small parts, which may have come loose inside the carton during shipment.

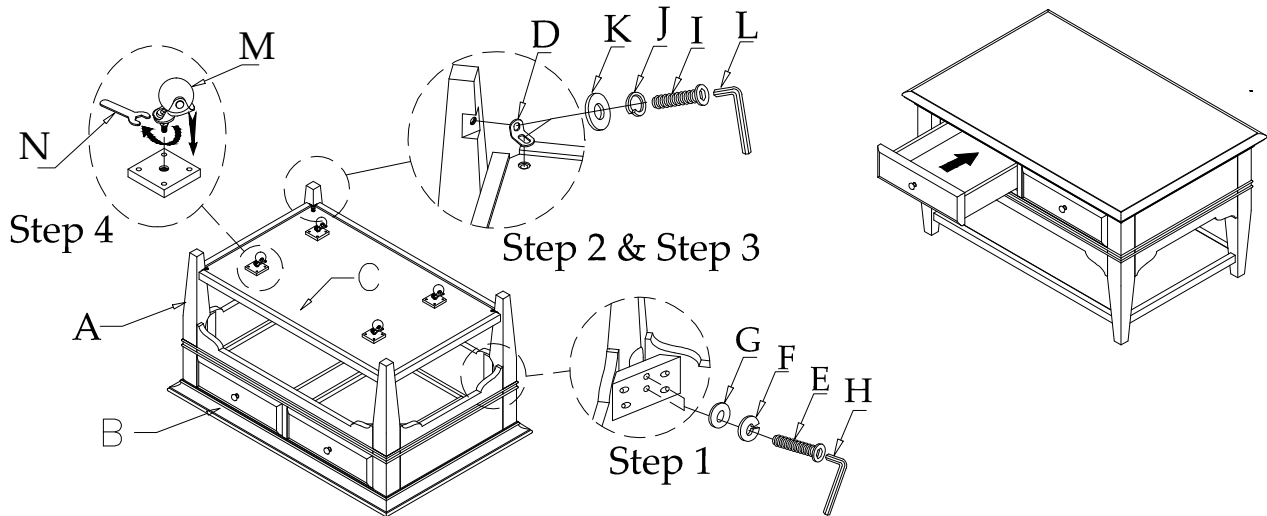

To prevent possible scratches and damage, this furniture should be assembled on a soft surface such as a blanket or carpet.

Step 1: Place the Table Top upside down. Attach three (3) Legs (A) into corners of the Table Top using the M5/16" x 2-1/4" Long Allen Head Bolts (E), Spring Washers (F) and Flat Washers (G). Do not fully tighten until after Step .

Step 2: Position the Shelf (C) into the notches of the three Legs already attached. Position the fourth Leg into the corner of the Table Top and Shelf. Attach the top of the Leg using the same Bolts and Washers as in previous step.

Step 3: Attach the Shelf to the Legs using the L-Brackets (D) and the M1/4" x 1/2" Long Bolts (I), Spring Washers (J) and Flat Washers (K). While pulling the Legs into the notch, tighten the Bolts with the Allen Wrench (L). Fully tighten all the bolts with Allen Wrench (H).

Step 4: If the Casters (M) will be used, install into the four plates mounted under the Shelf. Tighten with the Open Wrench (N).

Step 5: Carefully set the completed Table upright.