

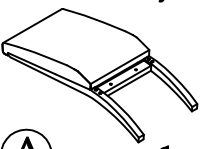

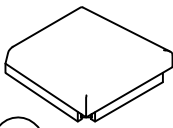

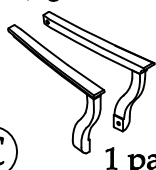



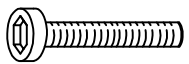
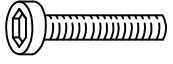
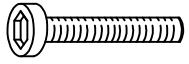

Components and Hardware List (for one chair)

<p>Back Assembly</p>  <p>A 1 pc.</p>	<p>Chair Seat</p>  <p>B 1 pc.</p>	<p>Arm (right and left)</p>  <p>C 1 pair</p>	<p>Front Leg</p>  <p>D 2 pcs.</p>
<p>M5/16"-18 x 3-1/8" Allen Head Bolt</p>  <p>E 4 pcs.</p>	<p>M 5/16"-18 x 1-3/4" Allen Head Bolt</p>  <p>F 4 pcs.</p>	<p>M 5/16"-18 x 2-1/8" Allen Head Bolt</p>  <p>G 4 pcs.</p>	<p>5/16" Spring Washer</p>  <p>H 12 pcs.</p>
<p>5/16" x 19 x 2mm Flat Washer</p>  <p>I 12 pcs.</p>	<p>5mm Allen Wrench</p>  <p>J 1 pc.</p>	<p>M 1/4"-20 x 1-1/2" Allen Head Bolt</p>  <p>K 2 pcs.</p>	<p>1/4" x 12 x 2mm Flat Washer</p>  <p>M 2 pcs.</p>
<p>4mm Allen Wrench</p>  <p>N 1 pc.</p>	<p>Wood Plug $\phi 13 \times 10$</p>  <p>L 2 pcs.</p>	<p>Be sure to check all packing material carefully for small parts, which may have come loose inside the carton during shipment.</p>	

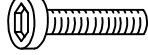

#50355
UPH Arm Chair 2in

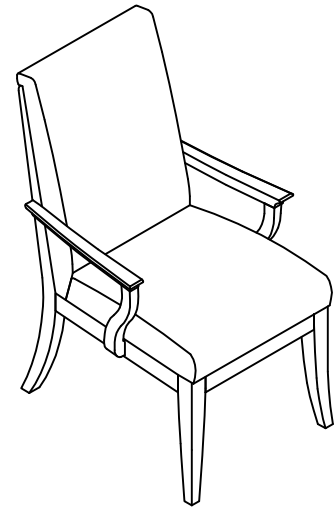
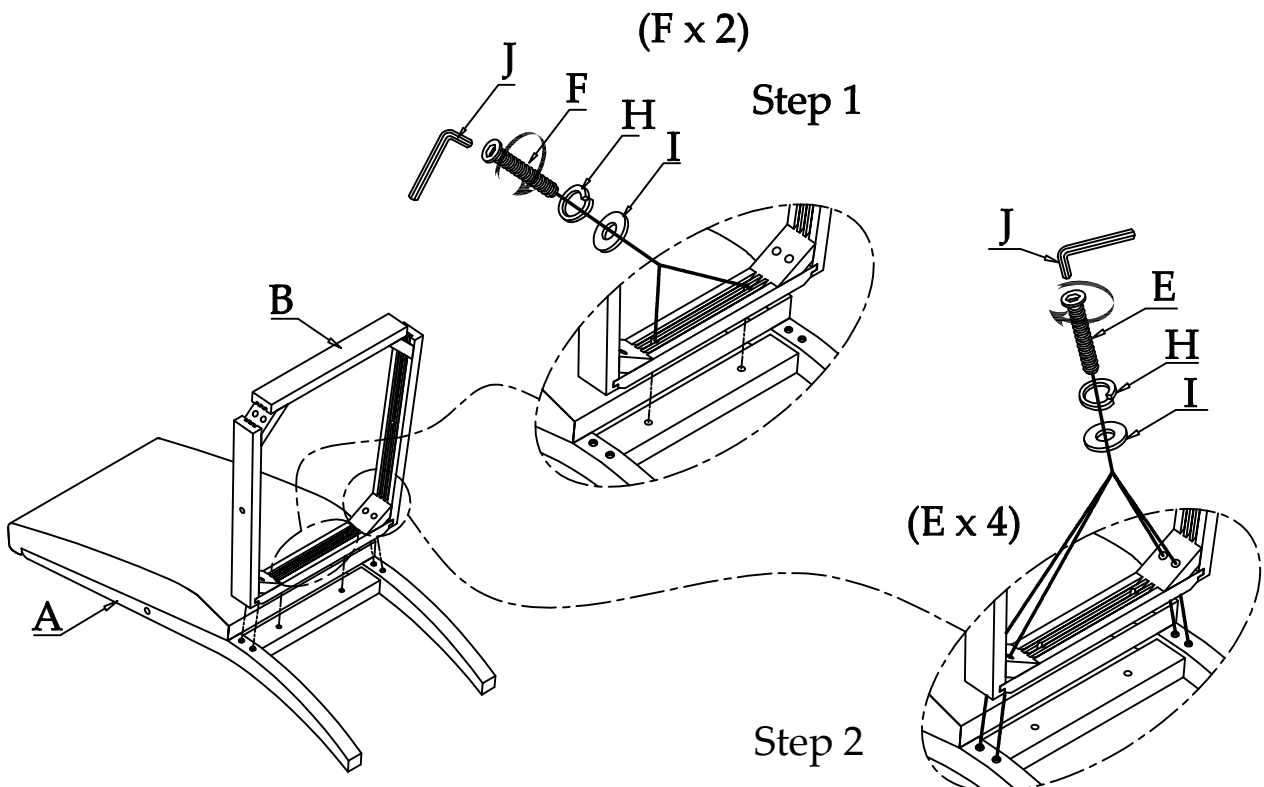

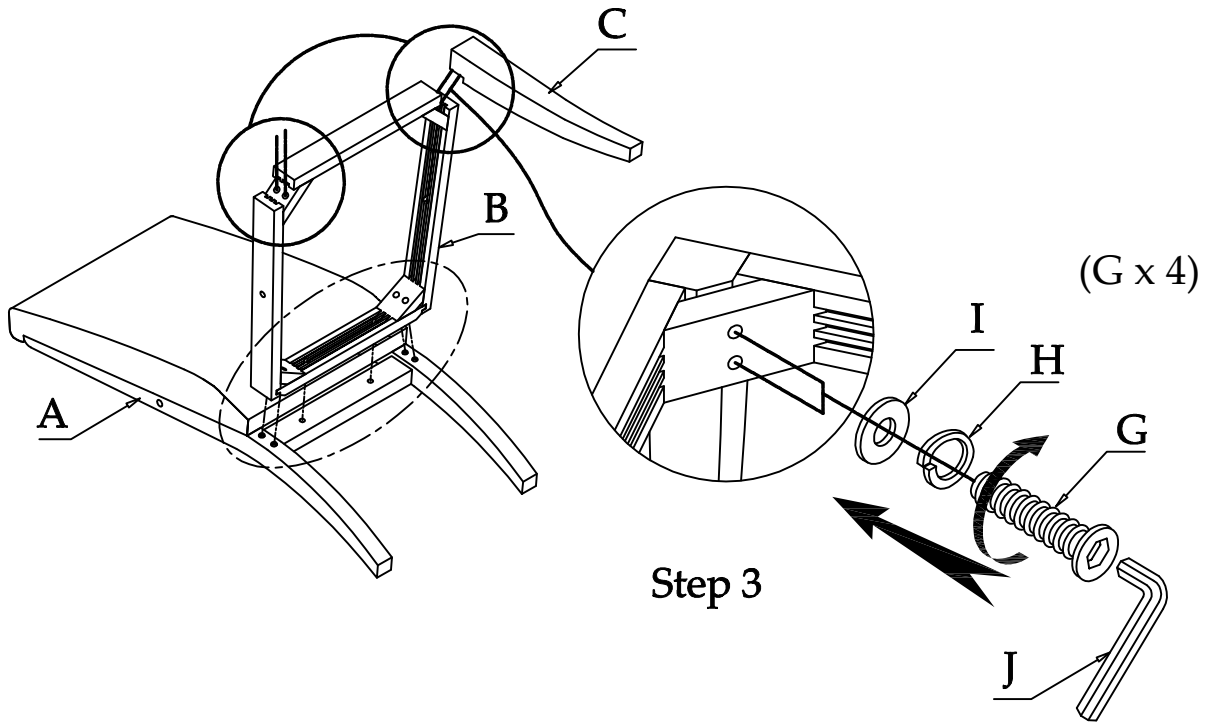

Step 3

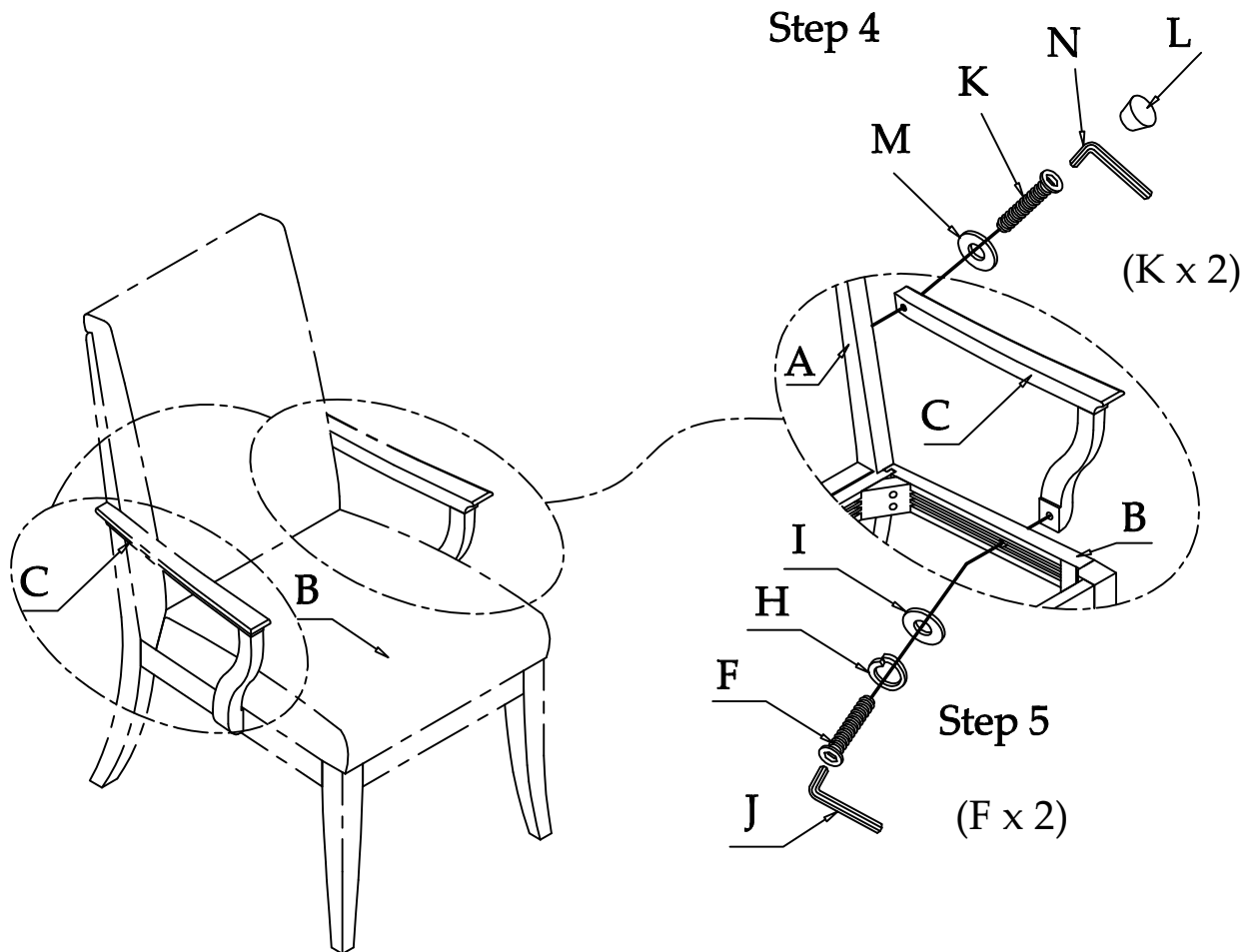

Step 4

Step 5