

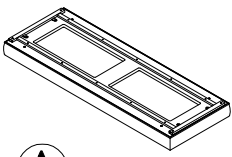

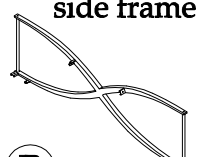

**Components and Hardware List**

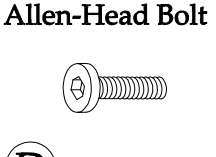
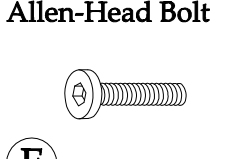

<p><b>Bench Top</b></p>  <p><b>(A)</b> 1 pc.</p>	<p><b>Bench Base side frame</b></p>  <p><b>(B)</b> 2 pcs.</p>	<p><b>Bench Base stretcher</b></p>  <p><b>(C)</b> 2 pcs.</p>	<p><b>1/4-20 x 1/2" Long Allen-Head Bolt</b></p>  <p><b>(D)</b> 8 pcs.</p>	
<p><b>1/4-20 x 5/8" Long Allen-Head Bolt</b></p>  <p><b>(E)</b> 4 pcs.</p>	<p><b>1/4" Spring Washer</b></p>  <p><b>(F)</b> 12 pcs.</p>	<p><b>1/4"x16*2mm Flat Washer</b></p>  <p><b>(G)</b> 12 pcs.</p>	<p><b>4mm Allen Wrench</b></p>  <p><b>(H)</b> 1 pc.</p>	<p>Screw Driver not included</p> 

Be sure to check all packing material carefully for small parts, which may have come loose inside the carton during shipment.

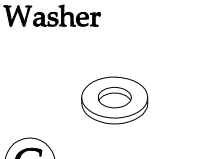
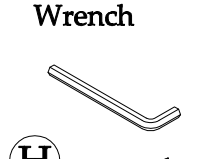
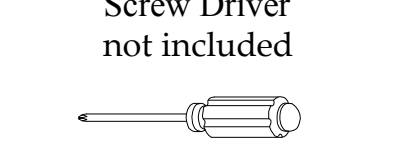
Step 1. Remove the frame under the seat cushion

STEP 1

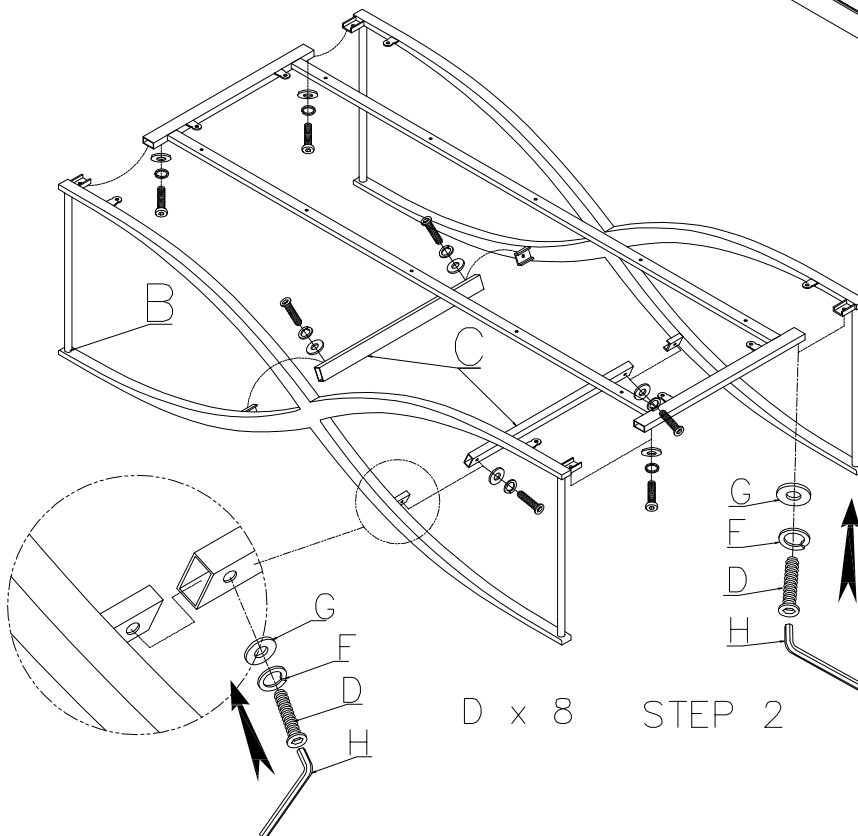
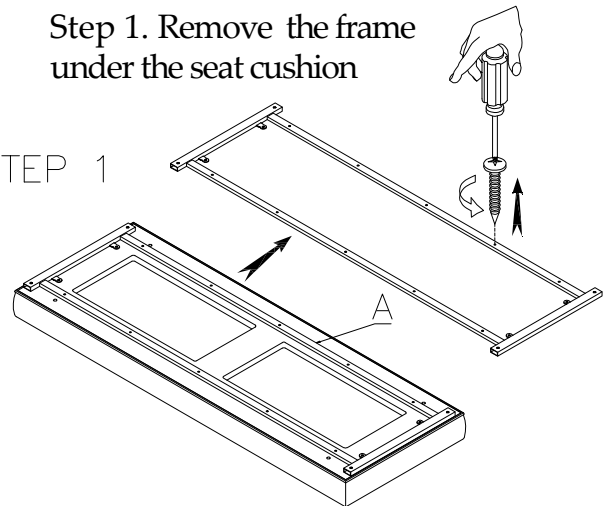

Step 3. Attach frame base to the seat cushion.

