

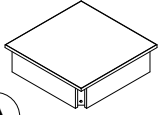





## Components and Hardware List

<p>Table Top</p>  <p><b>(A)</b> 1 pc.</p>	<p>Leg</p>  <p><b>(B)</b> 4 pcs.</p>		
<p>M5/16"-18x 2-3/8" Long Allen Head Bolt</p>  <p><b>(C)</b> 8 pcs.</p>	<p>M5/16" Spring Washer</p>  <p><b>(D)</b> 8 pcs.</p>	<p>M5/16" x 19 x2mm Flat Washer</p>  <p><b>(E)</b> 8 pcs.</p>	<p>5mm Allen Wrench</p>  <p><b>(F)</b> 1 pc.</p>

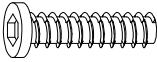

#46031-46131-46231  
Corner Unit

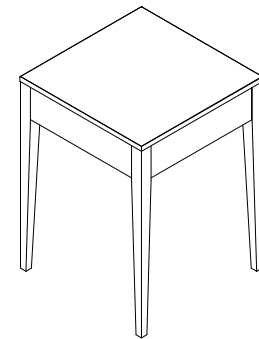
Be sure to check all packing material carefully for small parts, which may have come loose inside the carton during shipment.

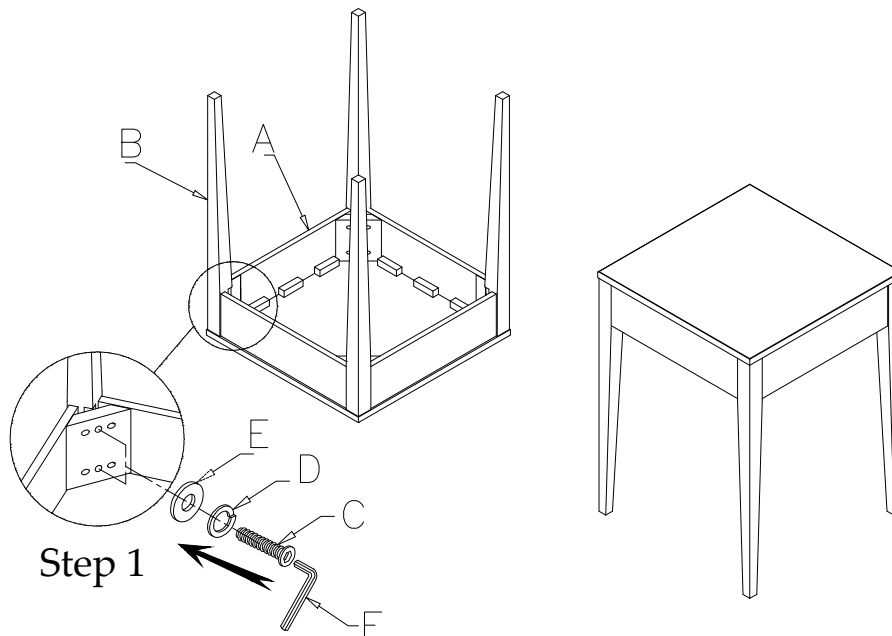

To prevent possible scratches and damage, this furniture should be assembled on a soft surface such as a blanket or carpet.

Step 1: Place the Table Top upside down. Attach a Leg (B) into each corner using the Allen Head Bolts (C), Spring Washers (D) and Flat Washers (E). Tighten using the Allen Wrench (F).

Set upright.