











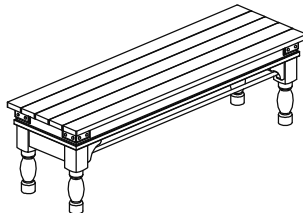

Components and Hardware List

<p>Bench Top</p>  <p>A 1 pc.</p>	<p>Leg (Right & Left)</p>  <p>B 4 pcs.</p>	<p>End Apron</p>  <p>C 2 pcs.</p>	<p>Metal Stretcher</p>  <p>D 2 pcs.</p>	 <p>#27358 Bench</p>
<p>φ5/16-18 x 1-3/4" Allen Head Bolt</p>  <p>E 8 pcs.</p>	<p>φ5/16-18 x 3/4" Allen Head Bolt</p>  <p>F 4 pcs.</p>	<p>5/16" Spring Washer</p>  <p>G 12 pcs.</p>	<p>5/16" Flat Washer</p>  <p>H 12 pcs.</p>	
<p>5mm Allen Wrench</p>  <p>I 1 pc.</p>	<p>φ1/4-20 x 2-7/8" Allen Head Bolt</p>  <p>J 2 pcs.</p>	<p>1/4" Spring Washer</p>  <p>K 2 pcs.</p>	<p>1/4" Flat Washer</p>  <p>L 2 pcs.</p>	

Be sure to check all packing material carefully for small parts, which may have come loose inside the carton during shipment. To prevent possible scratches or damage, this product should be assembled on a soft surface such as a blanket or carpet.

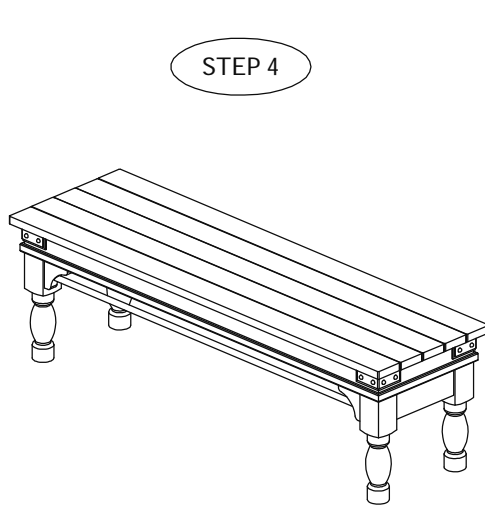
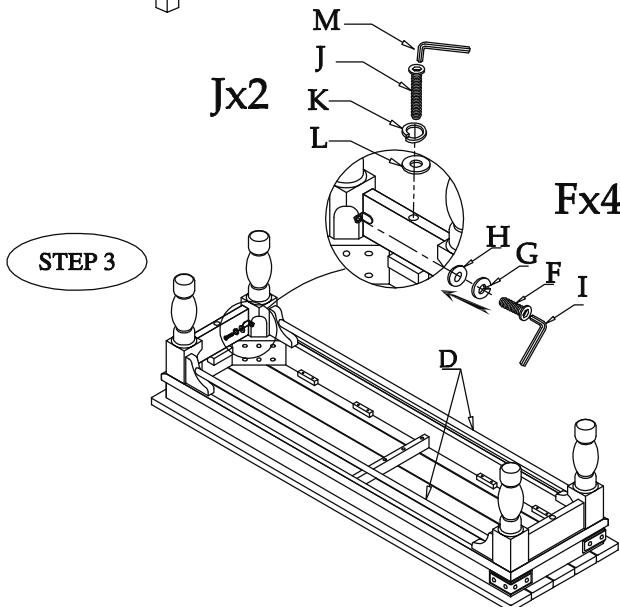
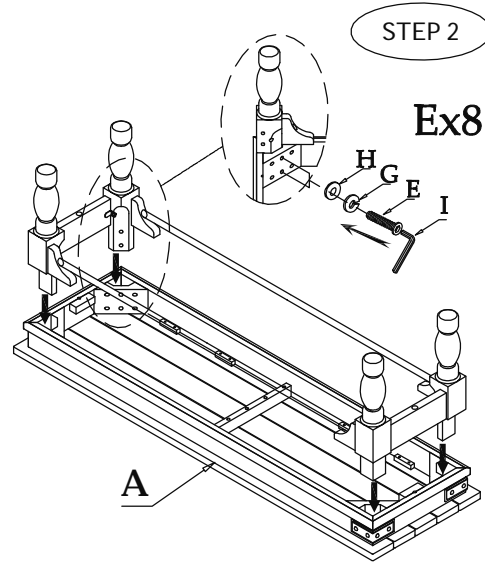
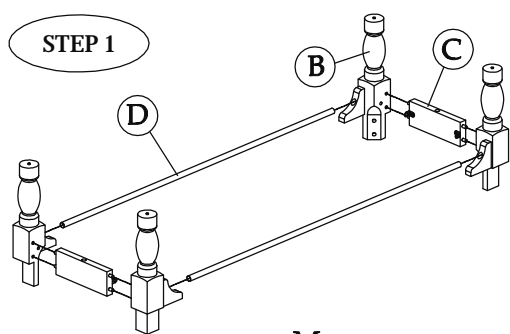

WARNING
This BENCH is designed and intended for seating only. To prevent against potential injuries and structural failures, this bench should NEVER be used for other than its intended purpose.