

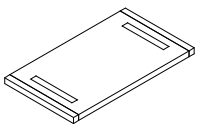

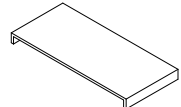

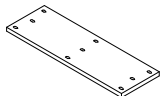

Components and Hardware packed with the Table Top

<p>Table Top</p>  <p>A 1 pcs.</p>	<p>Table Leaf</p>  <p>B 2 pcs.</p>	<p>Table Bridge Panel</p>  <p>C 2 pcs.</p>	<p>M5/16" x 2" Allen Head Bolt</p>  <p>D 10 pcs.</p>
<p>M5/16" x 1-1/2" Allen Head Bolt</p>  <p>E 12 pcs.</p>	<p>5/16" Spring Washer</p>  <p>F 22 pcs.</p>	<p>5/16" Flat Washer</p>  <p>G 22 pcs.</p>	<p>5mm Allen Wrench</p>  <p>H 1 pc.</p>

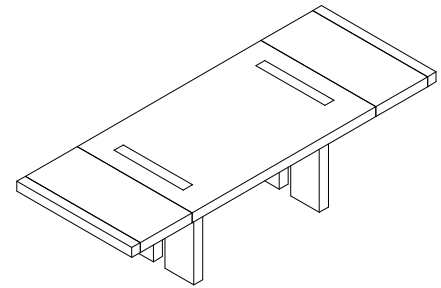

98850 Dining Table Top
98851 Dining Table Base

Components packed with the Table Base

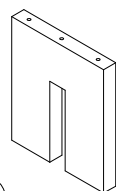
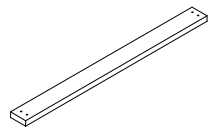
<p>Legs</p>  <p>I 2 pcs.</p>	<p>Middle Brace</p>  <p>J 1 pc.</p>
--	---

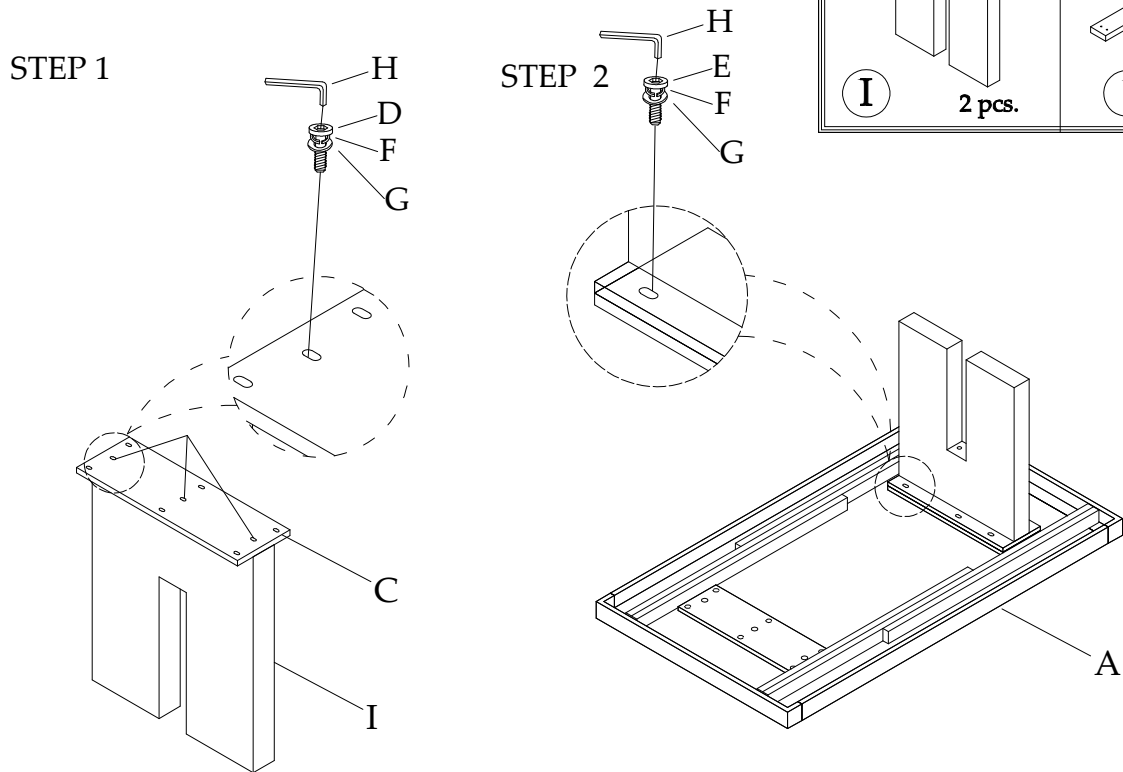

Separate, count and check all parts against the Components and Hardware List above. Failure to use the correct length bolts in the proper locations may result in an unsafe product and could also cause damage to the parts being assembled.

STEP 1:
Attach the Table Bridge Panels (C) to the top of the Legs (I) as shown using the 2" long Bolts (D), Spring Washers (F) and Flat Washers (G). Tighten with the Allen Wrench (H).

STEP 2:
Using two people, carefully place the Table Top (A) upside down on a clean, soft surface such as a blanket or carpet. Assemble the Table Bridge Panels and Legs to the bottom side of the Table Top using the 1-1/2" long Allen-Head Bolts (E), Spring Washers (F) and Flat Washers (G). Do not fully tighten Bolts.

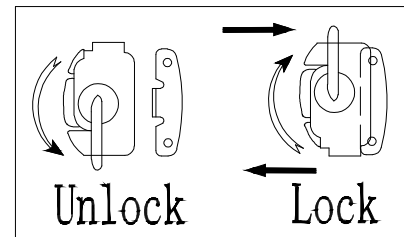
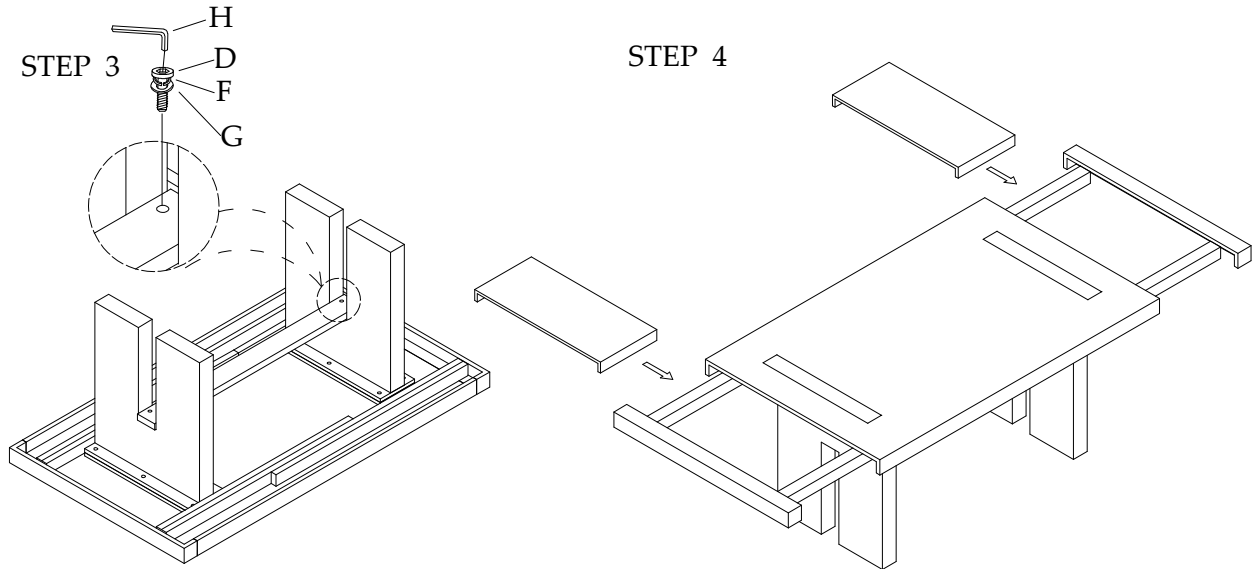

STEP 3:

Attach the Middle Brace (I) to the Legs as shown using the 2" long Bolts (D), Spring Washers (F) and Flat Washers (G). Tighten the Bolts just installed and the Table Bridge Panel at the top of the Legs.

STEP 4:

Using two people, carefully lift the completed table and set upright.

When installing or removing the Leaf, after unlocking the latches on the underneath side of the Table Top at the ends, pull the ends of the Table Top open. Remove or add the leaf, aligning the pins with the holes in the edges of the Top, slide the Table Top back together and re-lock the latches underneath.

Note: To prevent undue stress on the table and legs, if moving table, always use two people and carry the table from one location to the other.