

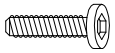





Components and Hardware List (for one chair)

M5/16" x 2-1/4" Allen Head Bolt  (A) 4 pcs.	M5/16" x 3-1/4" Allen Head Bolt  (B) 4 pcs.	M5/16" x 1-1/2" Allen Head Bolt  (C) 1 pc.
5/16" Spring Washer  (D) 9 pcs.	5/16" Flat Washer  (E) 9 pcs.	5mm Allen Wrench  (F) 1 pc.
Chair Back  (G) 1 pc.	Chair Seat  (H) 1 pc.	Front Legs  (I) 2 pcs.

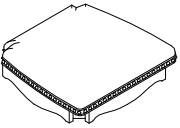
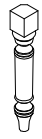
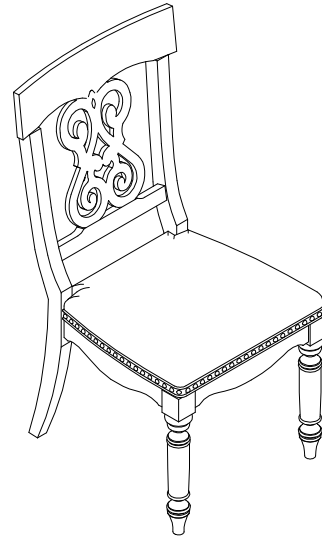

15957 Scroll Back Chair

Detail 1

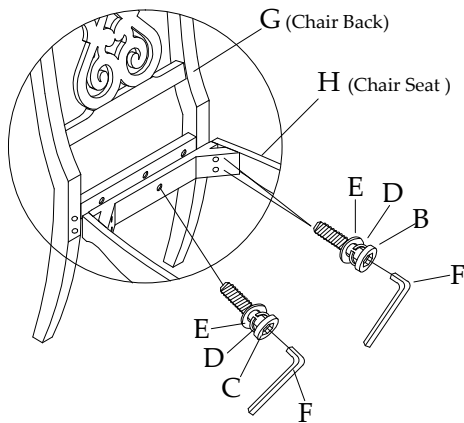

Detail 2

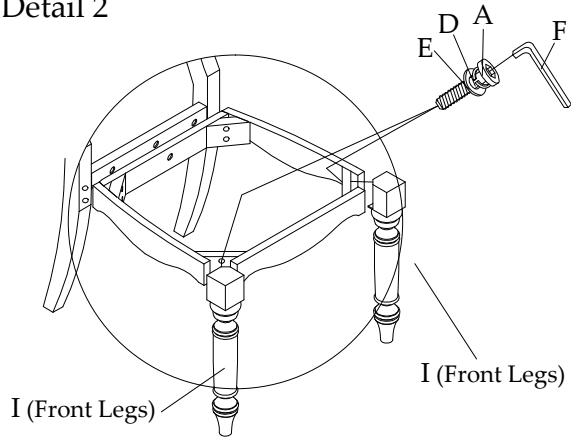

Be sure to check all packing material carefully for small parts, which may have come loose inside the carton during shipment. Separate, count and check all parts against the Components and Hardware List above. Failure to use the correct length bolts in the proper locations may result in an unsafe product and could also cause damage to the parts being assembled.

Step 1:

Place the Chair Back on a padded surface, and assemble the Chair Seat to the Chair Back (as shown in Step 1), using the 1-1/2" long Bolt (C), in the middle of the back, and the washers as shown. Install the 3-1/4" long Bolts (B), using the same washers, into the back corners of the Chair Seat. Do not fully tighten any bolts until after chair has been completely assembled.

Step 2: Assemble the Front Legs to the Chair Seat using the 2-1/4" long Bolts (A), and the same washers as before. Set the assembled Chair upright on a flat surface to level chair. Reach underneath the Chair Seat and tighten all Bolts using the Allen Wrench (F).